

Min flow: 10 l/min

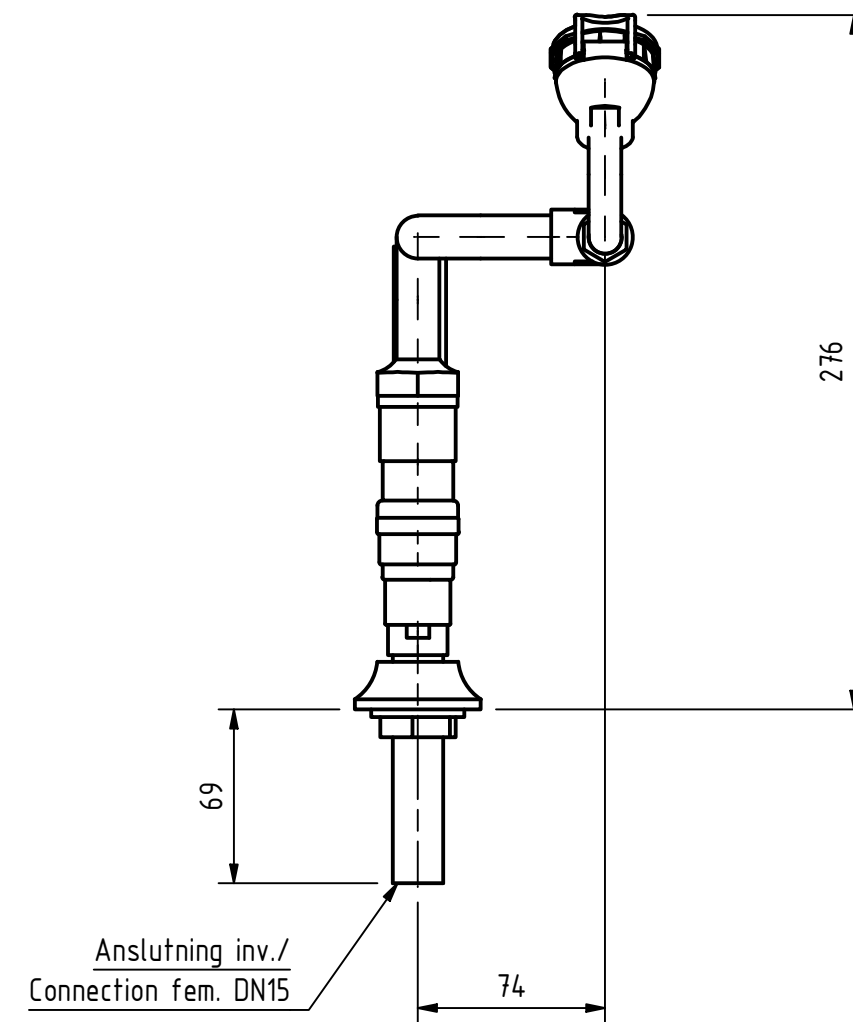
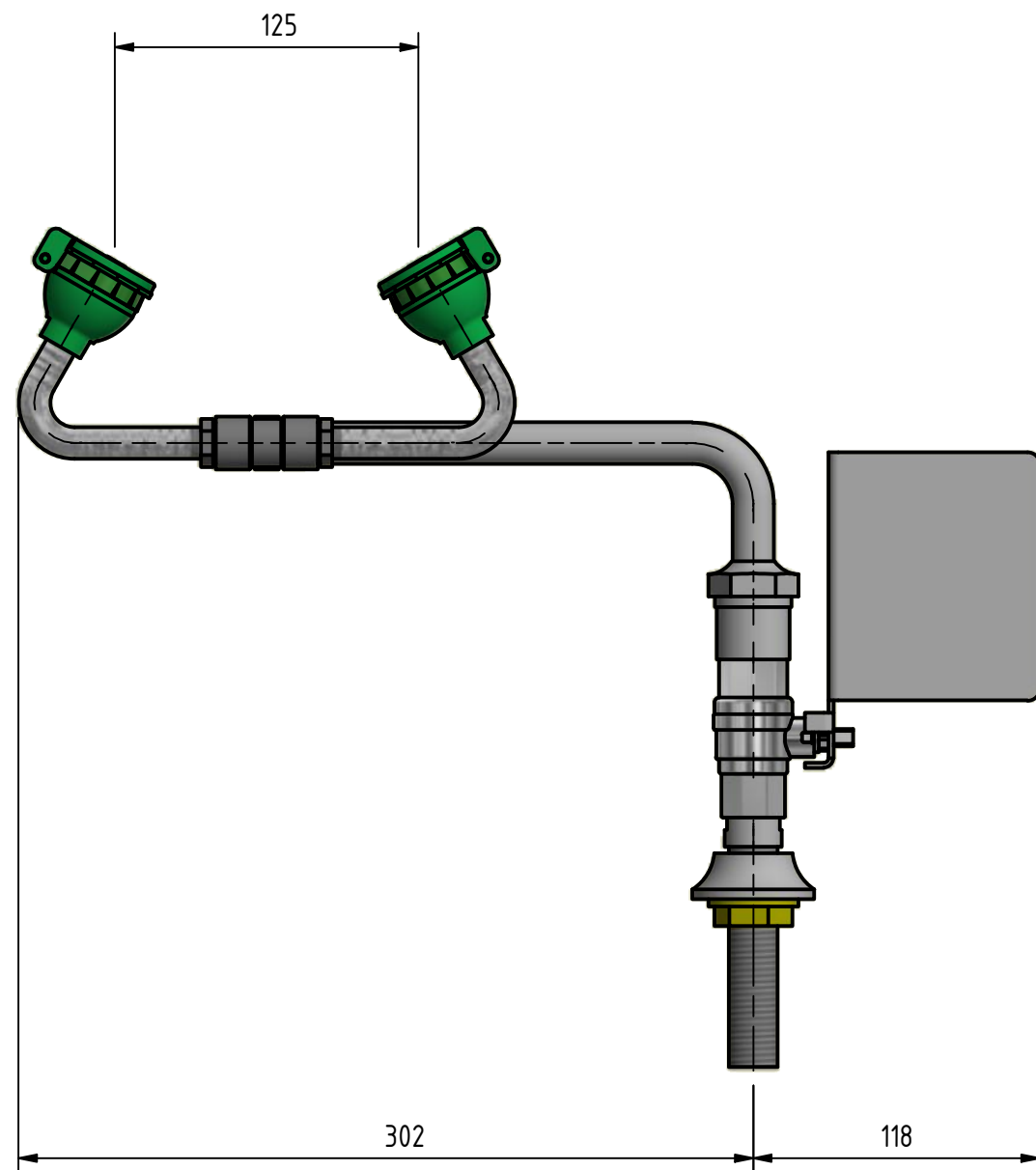

8223597