

Min flow: 26 l/min

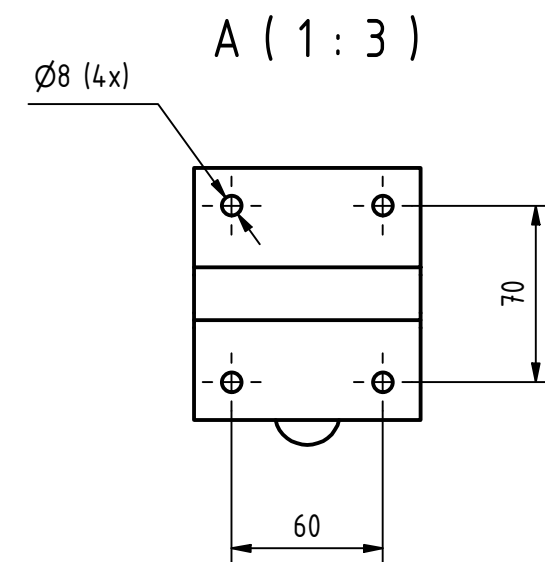
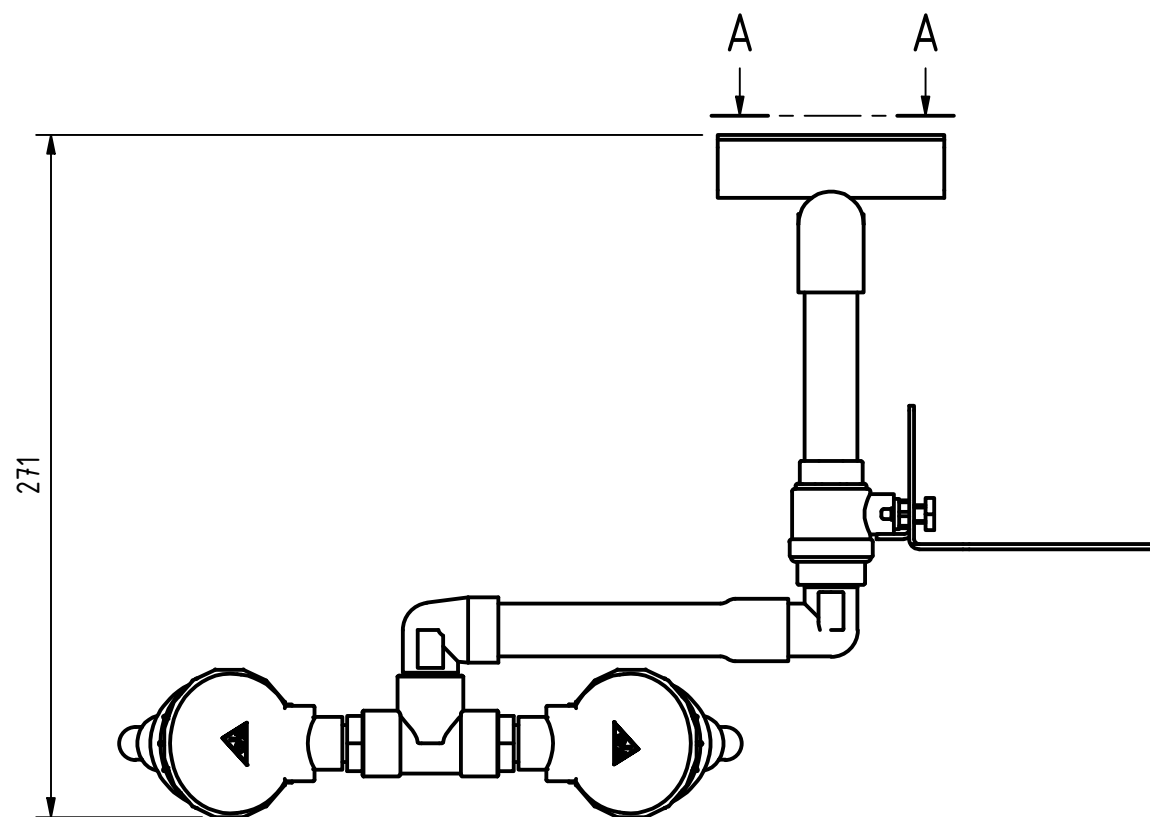
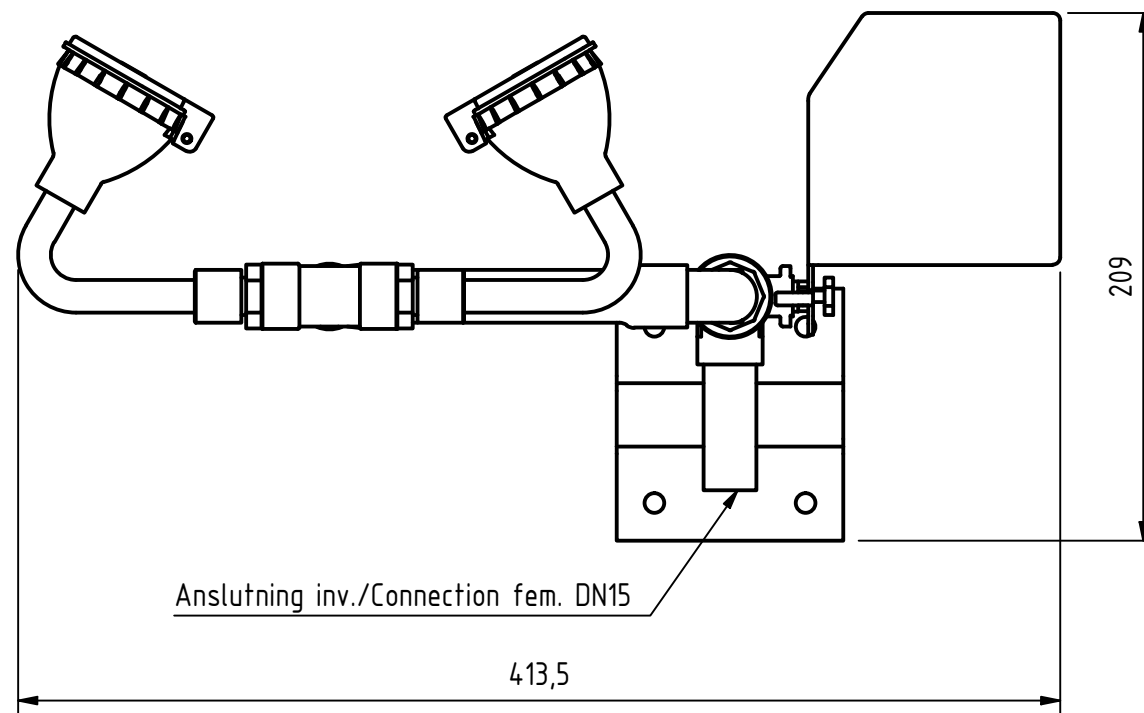

8223548