

Min flow: 20 l/min

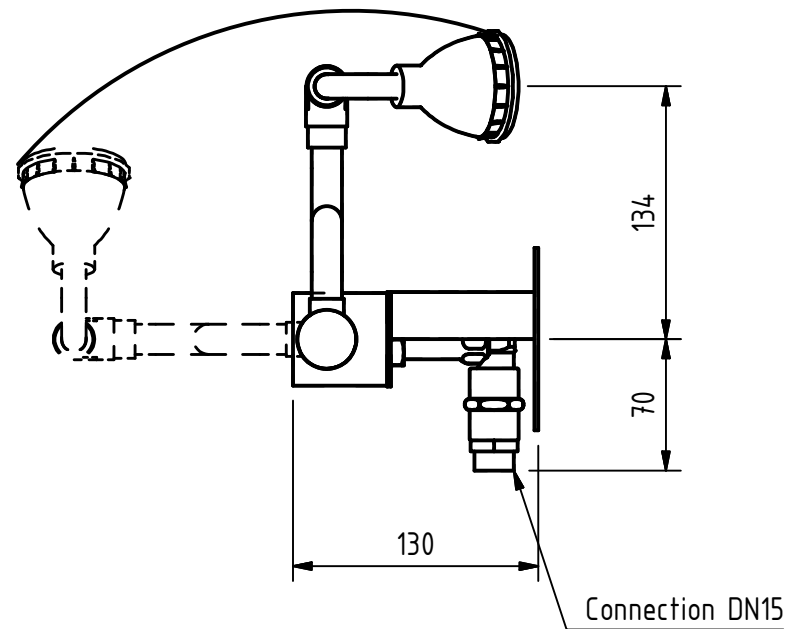
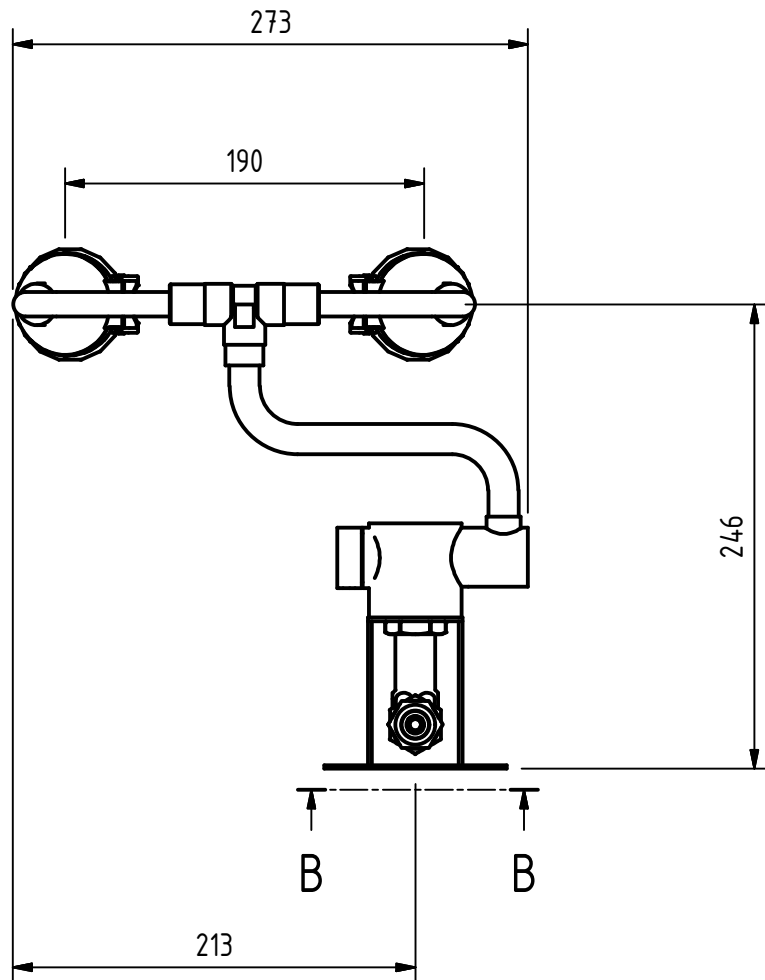

8223570